



NV**F2F** Installation guide

Component guide

NVELOPE® floor to floor (NVF2F) brackets and framework provide a framing system capable of larger spans than other bracket systems. Brackets are anchored to the building using primary fixings, and each bracket allows for final alignment and adjustment to suit the external cladding.

Brackets

NVF2F brackets are supplied in different sizes ranging from 72 mm to 222 mm. See table below for cavity depths that can be formed with the NVF2F system.

All brackets are supplied with hole sizes of 12.5 mm.

The NVF2F system is suitable for spanning between floor levels. Fixed and sliding points are determined by the rail fixing position.

Range of adjustment

Size (mm)	Min (mm)	Max (mm)
72	79	127
122	125	177
172	175	227
222	225	277

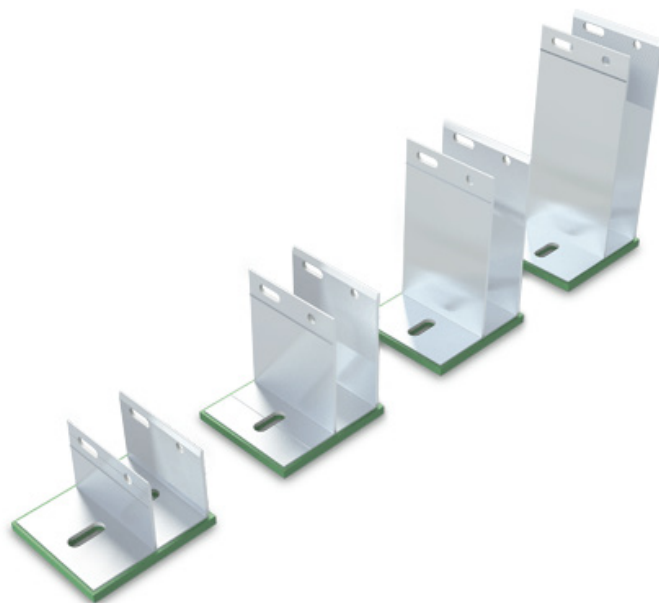

Box profiles

NVF2F box profiles are made from 6005A-T6 Aluminium.

They are extruded specifically to suit each project, with standard lengths of 3.6 m, and up to a maximum length of 7.2 m.

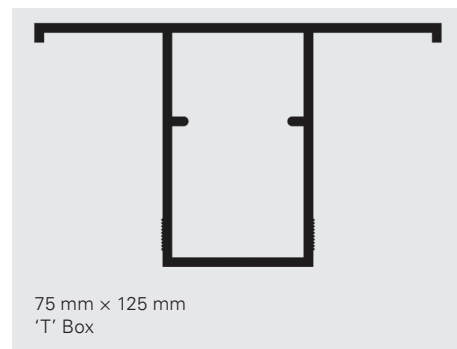
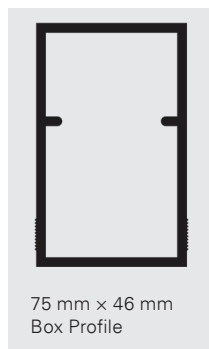

Fixings

Description	Article number	Image
Primary Fixing: MULTI-MONTI® Concrete Fixing	1520732	
Secondary Fixing: SX3 Fixing (Spigot)	1141978	
Secondary Fixing: includes M8 Bolt, M8 Washer, Nylon M8 Washer, M8 Nyloc Nut	1600079	

Installation guide

1. Secure NVF2F brackets to concrete substrate

- 1.1 Position the brackets at slab level.
- 1.2 Secure NVF2F brackets directly to the new/existing concrete substrate or structural steel frame using the MULTI-MONTI® primary anchor fixing.

Note: Due to the nature of the system, site pull-out tests are recommended for NVF2F. Please liaise directly with SFS for technical guidance on pull-out data.

2. Insert box profiles

Once a line of NVF2F brackets have been installed, 75 mm × 46 mm box profile or 75 mm × 125 mm T box profile can be slotted into the bracket leg at each position. It is important that time is taken to align/level the framework to a high standard.

- 2.1 Place the profiles in each of the brackets using the slot.
- 2.2 Move the profile into its vertical position allowing 10–15 mm 'expansion' between profiles.
- 2.3 Ease the profile outwards to form the specified cavity depth.
- 2.4 Check for line and level.
- 2.5 Secure the profile using M8 nut and bolt through holes created at the relevant fixed and sliding positions – please refer to Project Builder output for correct bracket positioning, fixed and sliding point positions.

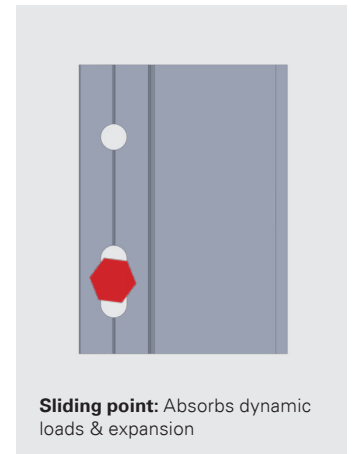
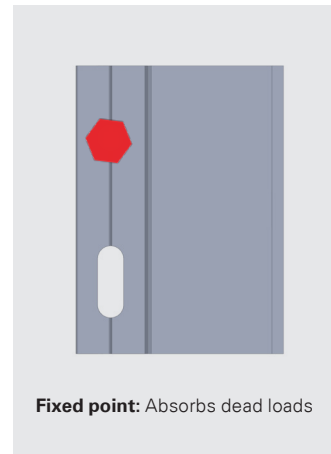

3. Affix box profiles

Once the brackets have been fixed to the substrate, and the box profiles have been adjusted for line and level, the box profiles are then secured through relevant fixed and sliding points located on the brackets.

As each profile is secured to the brackets, the top position bracket must be connected in the Fixed Point position. The bottom position bracket should be fixed in the Sliding Point position.

- 3.1 Using a suitable 9 mm drill bit, drill through the relevant fixed or sliding point location to allow an M8 bolt to be installed.
- 3.2 Ensure that the M8 bolt is installed correctly, observing the position of the nylon washers to separate the metal washer from the bracket. See Figure 1.

**Get in touch
for a project
specific static
calculation**

Installation guide

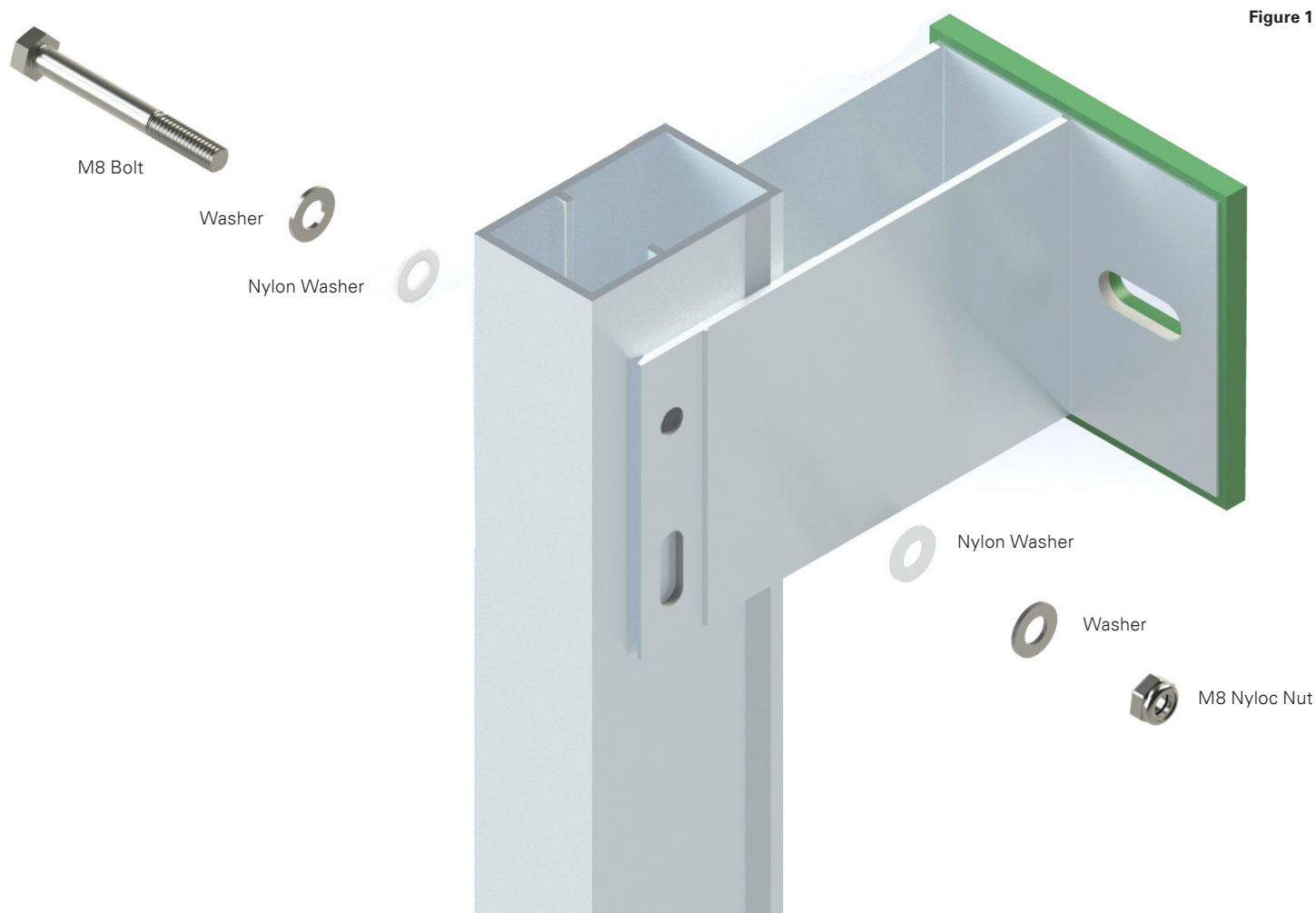

4. Join NVF2F box profiles together

Spigots are used to join NVF2F box profiles together by securing at one end and slotting into the next profile to be installed. This allows for thermal expansion as the profile is free to move in a vertical orientation.

- 4.1** Insert spigot into NVF2F box profile channel to the half way position.
- 4.2** Fix the spigot through the side of the lower box profile using a 29 mm SX3 fixing.
- 4.3** The next box profile is then installed by slotting over the spigot but do not fix, the profile must remain free to move allowing for thermal expansion.

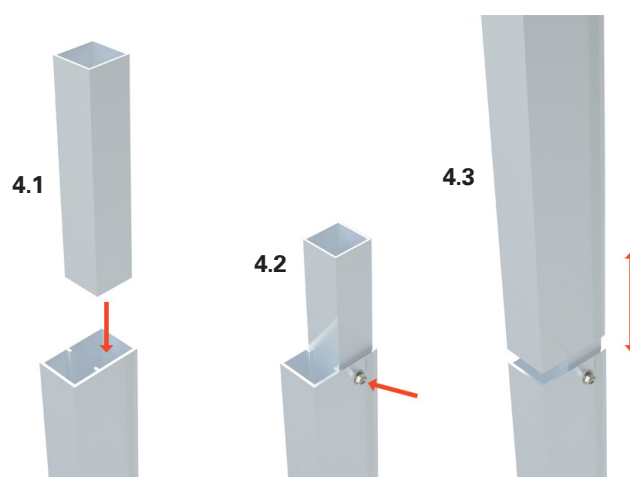

Installation guide

5. Check over

Once all brackets and profiles are installed to an area of cladding, final checks should be carried out:

- On the MULTI-MONTI® primary anchor torque settings
- To the line and level of the NVELOPE profiles in relation to each other
- To the position of bolts in each NVELOPE bracket

6. Install panels

- 6.1** Check profile positions in relation to actual panel positions and joints.
- 6.2** Raise the panel and support in horizontal position.
- 6.3** Adjust level and height of panel before fitting next panel above.
- 6.4** Repeat on next panels.
- 6.5** Panel joints should follow the manufacturers recommendations re: joint gaps horizontal and vertical.

Note: Typically, profiles are cut so that the panel(s) are located on one set of vertical profiles and do not 'bridge' an expansion gap between two profiles.

Notes

Fixings

Suitable primary anchors are designed to fix the brackets to a pre-determined grid to suit the cladding panel layout. Stainless steel fixings also assist in preventing bimetallic corrosion.

The size and type of primary fixing for the connectors will always be determined by the dynamic and dead loads they have to resist. Please liaise with us if you need further details.

Insulation

Where insulation is specified, it should be cut and tightly butted around the brackets and secured with the appropriate fixings. Sufficient insulation fixings should be provided to ensure that the insulation cannot block the ventilated cavity.



SFS Group Fastening Technology Ltd.
Division Construction
153 Kirkstall Road
Leeds, LS4 2AT
uk.info@sfsintec.biz
www.sfsintec.co.uk F Installation guide